

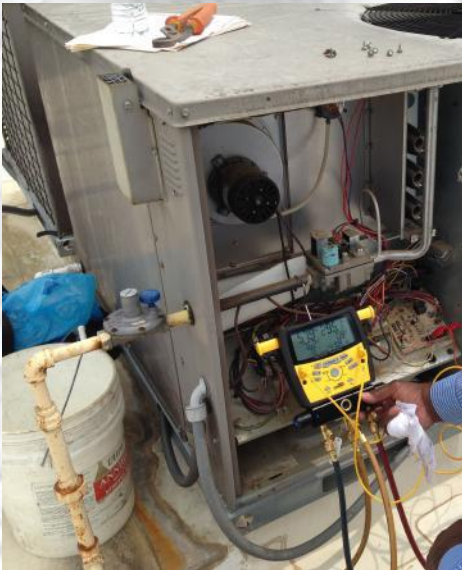

TLG ENGINEERING LIMITED

COMPANY PROFILE

WHO WE ARE

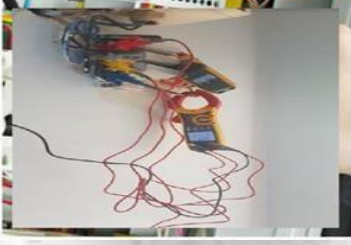
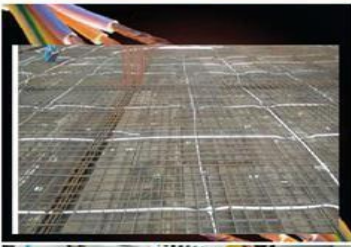

TLG Engineering Limited was established in 2019 Under the Tanzania companies act. Of 2002.

TLG Engineering Limited consists of 22 permanent employees including Directors, a Specialized Installer Electrician, Managers and a junior Accountant officer. Technical team include qualified electrical Engineers, qualified electricians, electrical assistants and general labourers.

TLG Engineering Limited is a member of the Contractors registration Board (CRB) Class 4 as electrical, mechanical, civil & building contractors together with members being registered with regulatory board (EWURA) **Class A, B & C and are committed to the latest Occupational Health & Safety Act.**

TLG Engineering Ltd has built a reputation for outstanding service and the highest levels of expertise when it comes to all of your electrical requirements. Our integrity has been never put in question and we always pride of it.



Mission Statement

To provide quality workmanship and customer service and maintain the highest level of professionalism, honesty and fairness in our relationships with our customers, employees and vendors

To grow by continually providing useful and significant products, services, and solutions to markets we already serve and to expand into new areas that build on our competencies and customer interests.

Vision Statement

To be the preferred Engineering contractor of choice across Tanzania and beyond country borders

A company that our customers want to work with and our employees are proud to work for.

Core Values

Safety

- At **TLG** Engineering Limited, safety is our primary focus. Audits are performed on a regular basis and every employee completes a safety training program. Our track record is something we take seriously every day.

Quality

- Every project **TLG** undertakes is completed by our team of highly skilled engineers & electricians with the best equipment and knowledge available. We strive to exceed our customers' expectations and appreciate their repeat business and referrals.

Customer Service

- Our customers are critical to us. From implementation to conclusion, we will work alongside our customers to ensure that their vision is being delivered by our team.

Teamwork

- Our experienced team consists of over 5 professionally licensed and registered engineers & electricians with more than 8 skilled managers and support staff. We are qualified and equipped to handle the challenges and complexities of any size job.

Integrity

- Customers, contractors, vendors, and suppliers will be able to count on **TLG** management and personnel to be reliable and trustworthy at every exchange. And adhere to the strictest moral and ethical codes of business conduct.

Company Information:

TLG ENGINEERING LIMITED

BRELA Reg#: 139689259
CRB Reg#: E4/144/12/2019
CRB Reg#: M4/50/07/2022
CRB Reg#: C4/495/07/2022
CRB Reg#: B4/697/07/2022

Incorporation date: 14th August, 2019

Branch Address: Kikwalaza - Mikumi – Kilosa.
P.O. BOX 101,
Kidatu, Tanzania

Cell Numbers: +255 788166660
+255 684 590314

Email Address: tlgengineering1@gmail.com

PRINCIPAL ACTIVITIES:

General contractors in Electrical,
in Civil,
in Building &
in Mechanical works

BANK DETAILS;

Bank Name: NMB Bank
Account no. : 21710024388
Currency : TZS

OUR MAIN SERVICES

1

Residential, Commercial and industrial electrical, mechanical, civil and building construction works

2

Electrical & mechanical material supply & maintenance

3

Complete HVAC solutions

4

Conditional based maintenance services (CBM)

5

Power factor correction

6

Generator services

7

Transformer services

8

Earthing protection system solutions

9

Switch gear services

10

Power system protection solutions

11

Motor Rewinding solutions

12

Industrial engineering systems Trainings

ELECTRICAL MAINTENANCE

Maintenance involves fixing any sort of electrical device should it become out of order or broken (known as repair, unscheduled, or casualty maintenance).

Electrical maintenance means the care and checklist of electrical equipment/instruments to avoid any breakdown or fault.

TLG Engineering Ltd provides premier electrical contracting and maintenance for public sectors and private customers in commercial, domestic and industrial markets throughout Tanzania. We offer short and long term maintenance contracts.

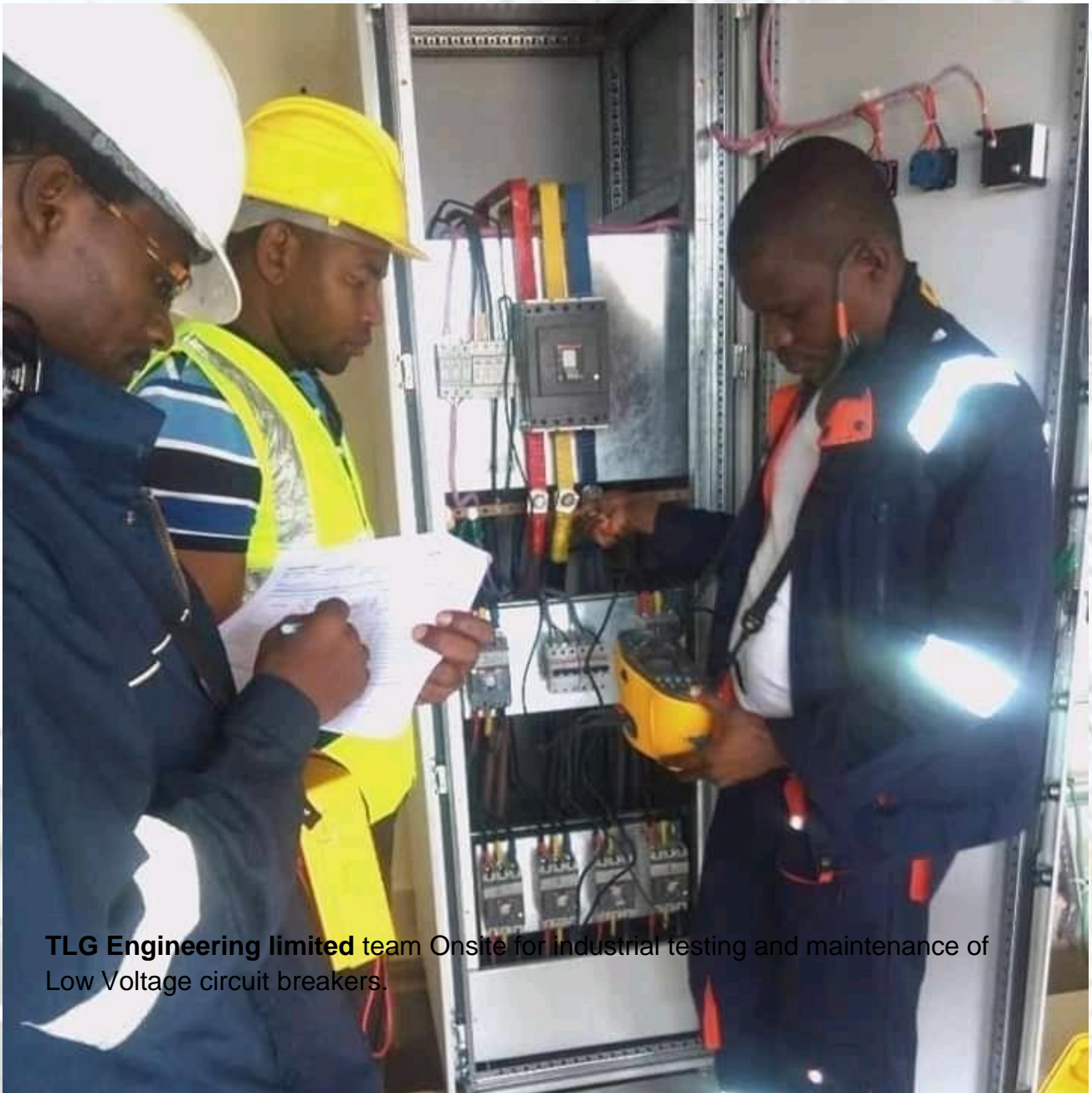

TLG Engineering limited team Onsite for industrial testing and maintenance of Low Voltage circuit breakers.

TLG ENGINEERING LIMITED team are always increasing items of technological growth through different training in our workshops or in different venues as matter raised.



TLG Engineering limited team in one of training at Africab Group Tanzania which is the one leading manufacturer of wide range of electrical products like wires and cables, transformers, switch gears, PVC conduit pipes and trunking

COMMERCIAL BUILDING ELECTRICAL INSTALLATION



TLG Engineering Limited has adopted international standards as per IEC 60364.

IEC 60364-8-1:2019(E) provides additional requirements, measures and recommendations for the design, erection and verification of all types of low-voltage electrical installation including local production and storage of energy for optimizing the overall efficient use of electricity.

EARTH FAULT LOOP IMPEDANCE TESTING AS AMONG OF OUR SERVICES

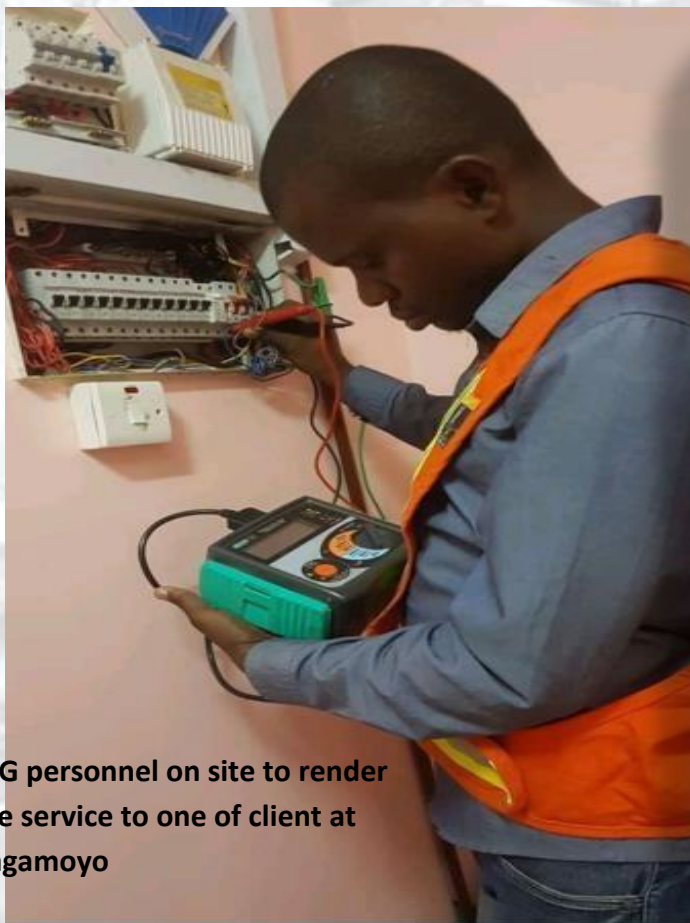
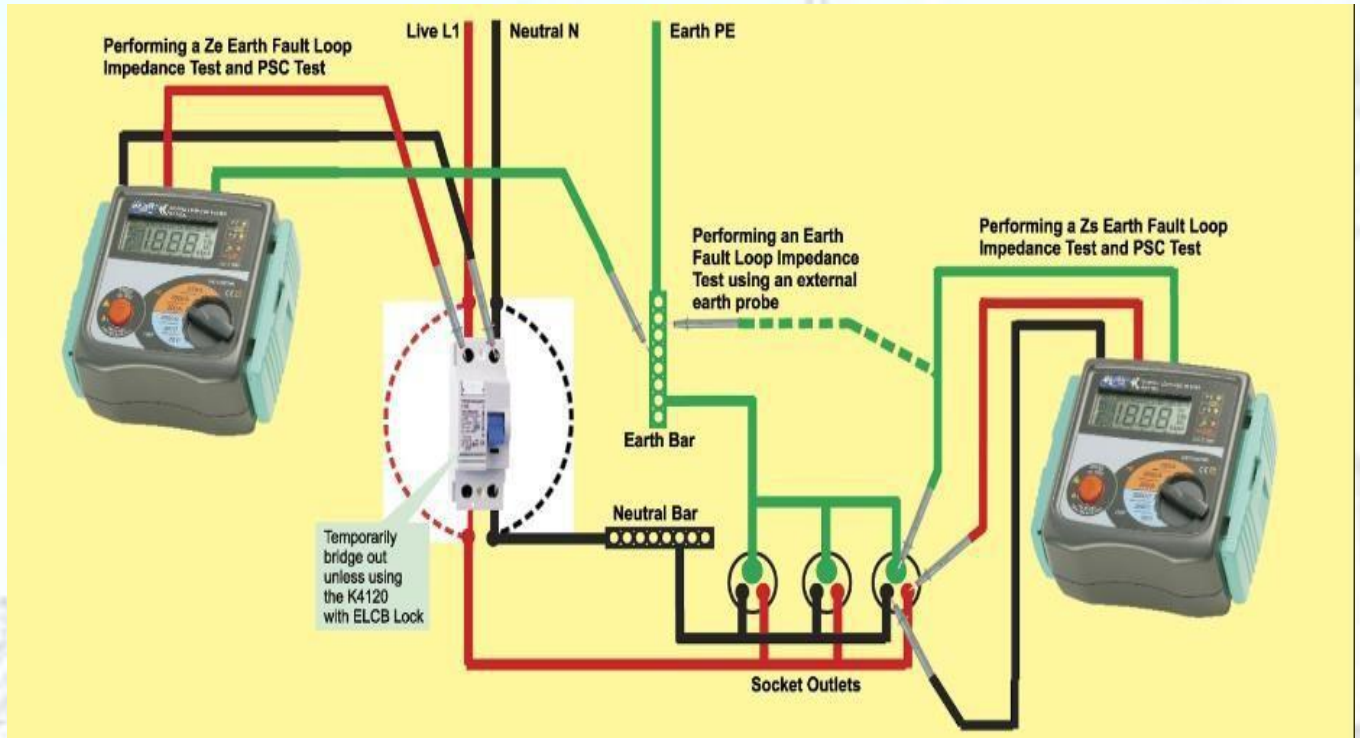

TLG personnel on site to render the service to one of client at Bagamoyo

In order to ensure the operation of the protective devices within the installation (such as MCB's & RCD's), the Earth Fault Loop Impedance value must be measured at the furthest point of the circuit and compared with the requirements found in **BS 7671**.

If the measured value is higher than the allowed in **BS 7671**, than the circuit is **not safe**

This test ensures house protection integrity & reliability

EARTH MATS INSTALLATION AS ONE OF OUR SERVICES

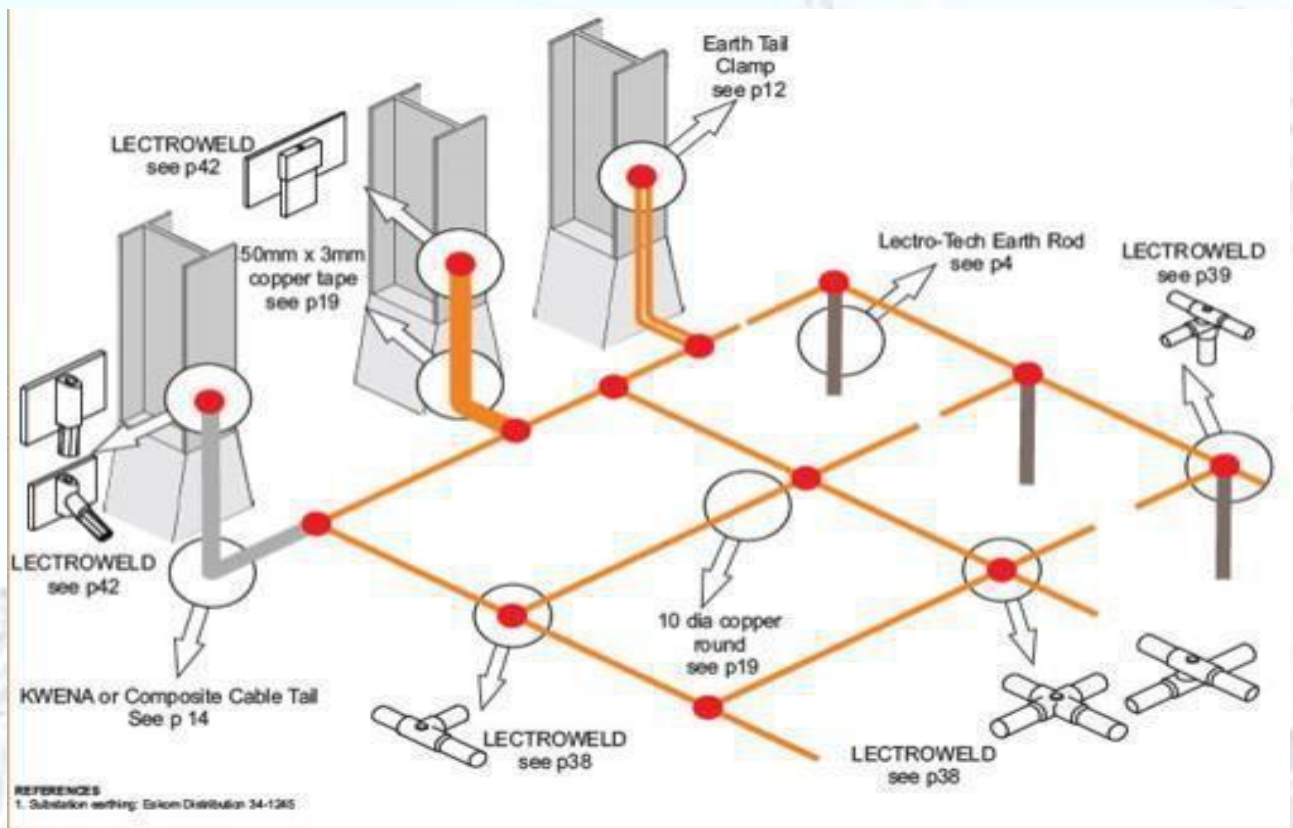

Earthing mats normally consist of a rectangular (or square) grid of copper wires that are buried in underground trenches mainly for provision of uniform potential gradient over a physical area.

TLG Engineering Limited
Design Works for earthing systems are in accordance to **IEEE-80/ IS 3043 / BS 7430**



TLG Engineering limited Team onsite for earthing system integrity verification and re-installation

POOR EARTHING SYSTEM HAS BEEN NOTED AS ONE OF CRITICAL PROBLEM ON DIFFERENT BUILDINGS WHICH CAUSES FIRE OUTBREAK, **TLG ENGINEERING LIMITED** WE HAVE SOLUTION FOR YOU.





COMPANY CREDENTIALS



No. 01167

CONTRACTORS REGISTRATION BOARD
CERTIFICATE OF REGISTRATION

This is to Certify that

TLG Engineering Limited

is registered as

ELECTRICAL WORKS CONTRACTOR

Class Four

Registration No. **E4/144/12/2019** Category **Local**

In accordance with the provisions of The Contractors Registration Act No. 17 of 1997

In witness whereof the common seal has been affixed

hereto on this 30th day of December, 2019

Registrar

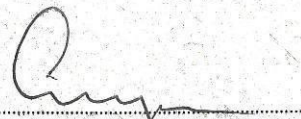

Chairman

This Certificate is held subject to the By-laws made under the Act.



CONTRACTORS REGISTRATION BOARD

HEAD OFFICE
P.O. Box 13374
DAR ES SALAAM
Tel: 255 22 2131169,
2137963/2
Fax: 255 22 2137964
E-mail: crbhq@crbtz.org
Web: www.crb.go.tz

Ref. No. : M4/233

Date: 06/07/2022

M/S. TLG ENGINEERING LIMITED
P.O BOX 101 MOROGORO

Dear Sir / Madam,

Re: REGISTRATION AS MECHANICAL WORKS CONTRACTOR

This is to confirm that after having paid Registration Fee and year 2022 Annual Subscription Fee vide our Receipt No. **CRB-R-2022-258** dated **06/07/2022** you are now registered with this Board as a **MECHANICAL** Contractor Class 4 with the effect from **06/07/2022**.

Your Registration Number is : **M4/50/07/2022**

You are now allowed by law to take up MECHANICAL contracts worth up to **TShs. 900,000,000.00** for any one single contract.

Your registration Certificate is being prepared and you will be informed when it is ready for collection.

Yours faithfully,

CONTRACTORS REGISTRATION BOARD

/RHO BEN NKORI

REGISTRAR



CONTRACTORS REGISTRATION BOARD

HEAD OFFICE
P.O. Box 13374
DAR ES SALAAM
Tel: 255 22 2131169,
2137963/2
Fax: 255 22 2137964
E-mail: crbhq@crbtz.org
Web: www.crb.go.tz

Ref. No. : CW4/2074

Date: 06/07/2022

M/S. TLG ENGINEERING LIMITED
P.O BOX 101 MOROGORO

Dear Sir / Madam,

Re: REGISTRATION AS CIVIL WORKS CONTRACTOR

This is to confirm that after having paid Registration Fee and year 2022 Annual Subscription Fee vide our Receipt No. **CRB-R-2022-258** dated **06/07/2022** you are now registered with this Board as a **CIVIL Contractor Class 4** with the effect from **06/07/2022**.

Your Registration Number is : **C4/495/07/2022**

You are now allowed by law to take up CIVIL contracts worth up to **TShs. 2,000,000,000.00** for any one single contract.

Your registration Certificate is being prepared and you will be informed when it is ready for collection.

Yours faithfully,

CONTRACTORS REGISTRATION BOARD

RHO BEN NKORI

REGISTRAR



CONTRACTORS REGISTRATION BOARD

HEAD OFFICE
P.O. Box 13374
DAR ES SALAAM
Tel: 255 22 2131169,
2137963/2
Fax: 255 22 2137964
E-mail: crbhq@crbtz.org
Web: www.crb.go.tz

Ref. No. : **BW4/2030**

Date: 06/07/2022

M/S. TLG ENGINEERING LIMITED
P.O BOX 101 MOROGORO

Dear Sir / Madam,

Re: REGISTRATION AS BUILDING WORKS CONTRACTOR

This is to confirm that after having paid Registration Fee and year **2021** Annual Subscription Fee vide our Receipt No. **CRB-R-2022-258** dated **06/07/2022** you are now registered with this Board as a **BUILDING Contractor Class 4** with the effect from **06/07/2022**.

Your Registration Number is : **B4/697/07/2022**

You are now allowed by law to take up **BUILDING** contracts worth up to **TShs. 1,800,000,000.00** for any one single contract.

Your registration Certificate is being prepared and you will be informed when it is ready for collection.

Yours faithfully,

CONTRACTORS REGISTRATION BOARD

RHO BEN NKORI

REGISTRAR



TANZANIA

C.1



Certificate of Incorporation of a Company

Section 15

No: 139689259

I HEREBY CERTIFY THAT

TLG ENGINEERING LIMITED

is this day incorporated under the Companies Act, 2002
and that the Company is Limited.

GIVEN under my hand at Dar es Salaam this 14th day of
AUGUST TWO THOUSAND AND NINETEEN.



SNR ASST. REGISTRAR OF COMPANIES

CTIN: 0980034



TANZANIA REVENUE AUTHORITY

CERTIFICATE OF REGISTRATION
FOR
TAXPAYER IDENTIFICATION NUMBER (TIN)

(ISSUED UNDER SECTION 23 OF THE TAX ADMINISTRATION ACT 2015)

THIS IS TO CERTIFY THAT

TLG ENGINEERING LIMITED

HAS BEEN REGISTERED WITH THE TANZANIA REVENUE AUTHORITY
AND ASSIGNED THE TAXPAYER IDENTIFICATION NUMBER

139-689-259

WITH EFFECT FROM: **23 February 2020**

TRA LOCATION: **MOROGORO**

TAX OFFICE: **KILOSA**

PHYSICAL LOCATION:

STREET / AREA: NEAR BASTIAN HOTEL BESIDE MIKUM

Elijah G. Mwandumbya

OFFICIAL SEAL

AG. COMMISSIONER FOR DOMESTIC REVENUE

NOTE: THE REQUIREMENTS UNDER WHICH THIS CERTIFICATE IS ISSUED ARE STATED OVERLEAF

ID 4275



TFN. 226
(Rev. 2/96)

JAMHURI YA MUUNGANO WA TANZANIA

REG. NO. 13962925

LESENI YA BIASHARA

B 03351490

(Imetolewa chini ya Sheria ya Leseni za Biashara Na. 25 ya Mwaka 1972 marekebisha ya mwaka 1980 na masharti yaliyo nyuma)

*Futa isiyotakiwa

1. Ofisi iliyotolewa... HALMACHAURI (W) KILOSA
2. Nambari ya Ushuru wa mapato... 139-629-259
3. Leseni imetolewa kwa... TLG ENGINEERING LIMITED
kuendesha biashara ya... ELECTRICAL WORKS CONTRACTOR
katika Wilaya/Kanda* ya... KILOSA Mtaa KIKWALAZA
4. Ni ya Shina/Tawi*
Ada Sh. 301,000/= Nambari ya Stakabadhi... 22942
ya tarehe... 6/03/2020
5. Mpya inaendeleza* muda wa Leseni Na... KUPYA
ya tarehe

(ii) Muda wa leseni hii utaiishia 30 Juni 20... 5/03/2021

Tarehe... 6/03/2020

GP. Dsm

Sahibu wa Muhuri wa Mtaa Leseni
DISTRICT TRADE OFFICER
KILOSA

ERB-B-0116002882



UNITED REPUBLIC OF TANZANIA



ENGINEERS REGISTRATION BOARD



Certificate of Registration

(Under the Engineers Registration Act, 1997)

It is hereby certified that

Thomas P. Sungi

having satisfied the requirements for registration as a

PROFESSIONAL ENGINEER

under the provisions of the Engineers Registration Act, 1997, was

registered as such on the 30th day of October, 2018

in the discipline of Electrical engineering

and was given registration number 5437

Sealed and given under our hands at Dar es Salaam

this 27th day of December, 2018.

Signature of Eng. P. Baloz

Eng. P. Baloz Ag. Registrar

Signature of Eng. Prof. N. M. Lema

Eng. Prof. N. M. Lema Chairman

Signature of Eng. Nuberis P. J. Nyange

Eng. Nuberis P. J. Nyange Board Member



Not valid without Hologram Sticker, photograph of the bearer and practicing Licence

ENERGY AND WATER UTILITIES REGULATORY AUTHORITY



ewura
Energy and Water Utilities Regulatory Authority



ELECTRICAL INSTALLATION CERTIFICATE

NO: 123.233.02240-F

This is to certify that

TEOMAS ETEU SUNCI

has fulfilled the licensing requirements as stipulated in the Electricity (Electrical Installation Services) Rules 2015 for obtaining

Electrical Installation Licence Class "B"

This Certificate was approved by the EWURA Board of Directors at its meeting held on **07** day of **JUNE** year **2017**.

Note: When carrying out electrical installation work the holder of this certificate must have a valid Electrical Installation Licence.

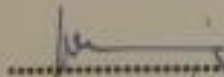
.....

Secretary to the Board

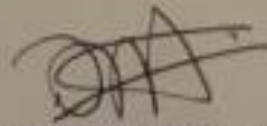
.....

Director General

SEAL

07-06-2017
.....

Date of Issue

ERB-B- 0116002659



UNITED REPUBLIC OF TANZANIA
ENGINEERS REGISTRATION
BOARD



Certificate

of Registration

(Under the Engineers Registration Act, 1997)

It is hereby certified that

Babari A. Kingazi

having satisfied the requirements for registration as a

PROFESSIONAL ENGINEER

under the provisions of the Engineers Registration Act, 1997, was

registered as such on the 24th day of August, 2018

in the discipline of Civil engineering

and was given registration number 5362.

Sealed and given under our hands at Dar es Salaam

this 20th day of September, 2018.

Eng. P. Barozi
Ag. Registrar

Eng. Prof. N. M. Lema
Chairman

Eng. Nuberis P. J. Nyange
Board Member

ARCHITECTS AND QUANTITY SURVEYORS REGISTRATION BOARD
CERTIFICATE OF REGISTRATION



This is to certify that

Kissa Nixon Jacob

Is registered as **an Architectural Technologist**

With registration number **ATL 3.3.12/17**

In accordance with the provisions of the Architects and Quantity Surveyors
(Registration) Act No 4 of 2010.

In witness whereof the common seal has been affixed hereto on this day of
22nd December, 2017



Chairperson

Member

Registrar

This certificate is held subject to the provisions of the By-laws made under
the Act.

No: **CO. 1481**

ENERGY AND WATER UTILITIES REGULATORY AUTHORITY



ELECTRICAL INSTALLATION CERTIFICATE
NO. EUSC-2018-1006-C



This is to certify that
MUHAMMAD A. OSMAN

has fulfilled the licensing requirements as stipulated in the Electricity (Electrical Installation Services) Rules 2015 for obtaining

Electrical Installation Licence Class "C"

This Certificate was approved by the EWURA Board of Directors at its meeting held on **23rd** day of **APRIL** year **2019**.

Note: When carrying out electrical installation work the holder of this certificate must have a valid Electrical Installation Licence.

.....

Secretary to the Board

.....

Director General

SEAL

23-04-2019

Date of Issue

ENERGY AND WATER UTILITIES REGULATORY AUTHORITY



ELECTRICAL INSTALLATION CERTIFICATE

NO. ELINB-2019-3241-C

**DIRECTOR GENERAL
ENERGY & WATER UTILITIES
REGULATORY AUTHORITY
4TH FLOOR, LAPP HOUSE
MAKOLE ROAD
P. O. Box 2887
DODOMA**

This is to certify that

.....HAMIS KITUNGUTU.....

has fulfilled the licensing requirements as stipulated in the Electricity (Electrical Installation Services) Rules 2019 for obtaining

Electrical Installation Licence Class "C"

This Certificate was approved by the EWURA Board of Directors at its meeting held on **23rd** day of **AUGUST** year **2019**.

Note: When carrying out electrical installation work the holder of this certificate must have a valid Electrical Installation Licence.

.....

Secretary to the Board

.....

Director General

SEAL

23-08-2019

Date of Issue



THE UNITED REPUBLIC OF TANZANIA

PRIME MINISTER'S OFFICE

MINISTRY OF LABOUR, EMPLOYMENT, YOUTH AND PEOPLE WITH
DISABILITY



OCCUPATIONAL SAFETY AND HEALTH AUTHORITY

REG. NO: NOSHC/1544

Certificate



This is to certify that

HAMIS ALLY KITUNGUTU

Has successfully completed

**National Occupational Safety and Health Course Module One
(NOSHC I)**

Held on: 4th to 22nd November 2019

Date of Issue: 17th December 2019



Joshua Matiko

**Director of Training,
Research & Statistics**





**Khadija H. Mwenda
Ag. Chief Executive**



**MOBIUS INSTITUTE
BOARD OF CERTIFICATION**

certifies that

SHADRACK ILOMO

has met the experience, training and examination requirements for conformity to ISO 18436-2 as

VIBRATION ANALYST: CATEGORY II

ISO/IEC 17024 accredited in accordance with ISO 18436-1

This certificate remains the property of Mobius Institute Board of Certification, www.mobiuscertification.org

Certification Number: **M-125960-01**
Date of Certification: **1-Dec-2018**
Certification Expires: **1-Dec-2021**

Jason Tranter, Managing Director
Mobius Institute Board of Certification



THE UNITED REPUBLIC OF TANZANIA
MINISTRY OF HOME AFFAIRS



FRTC No.

No:- 000800

FIRE AND RESCUE TRAINING CENTRE

CERTIFICATE

This is to certify that:-

Mr. / Mrs. / Miss **VEDASTUS BULEMO**
has attended a training in

FIRE WARDEN

held on 26th October, 2016 in recognition on whereof this Certificate is
awarded on this 28th day of October, 2016

.....
Coordinator,
Fire and Rescue Training Centre.

.....
Commandant,
Fire and Rescue Training Centre.

THE COMMANDANT
FIRE & RESCUE TRAINING CENTRE

LIST OF TECHNICAL STAFF

S/No	NAME	POSITION IN THE FIRM	TERM OF CONTRACT
1	Thomas P. Sungi	Managing Director	Permanent
2	Humphrey Koola	Technical Director	Permanent
3	Kissa Nixon Jacob	Business Operational Manager	Permanent
4	Peter S. Mlelwa	Technical Manager	Permanent
5	Omari Mkupete	Workshop Manager	Permanent
6	Hamis Kitungutu	SHEQ manager	Permanent
7	Shadrack Ilomo	CBM Specialist	Permanent
8	Aloyce Ngowi	Senior Electrical Engineer	Permanent
9	Festo Likungiro	Site Electrician	Permanent
10	Hussein S. Dimile	Motor Rewinder	Permanent
11	Mohamed A. Omari	Site Manager	Permanent
12	Bakari Kingazi	Civil technical Manager	Permanent
13	Vedastus Bulemo	Site Electrician	Permanent
14	Omari Saidi	Electrical Engineer	Permanent
15	Tito Wissa	Electrical Technician	Permanent















